

	A0	Initial release TMAX-1365-R47-M TMAX-1365-R82-M TMAX-1365-1R0-M TMAX-1365-4R7-M TMAX-1365-6R8-M TMAX-1365-8R2-M TMAX-1365-680-M TMAX-1365-101-M	2018/05/03	Heter	Roger
	A1	Add TMAX-1365-100-M TMAX-1365-330-M TMAX-1365-470-M	2018/06/08	Heter	Roger
	A2	Revision TMAX-1365-8R2-M	2018/07/16	Heter	Roger
	A3	Add TMAX-1365-3R3-M	2018/11/14	Heter	Roger
	A4	Add TMAX-1365-1R5-M TMAX-1365-2R2-M TMAX-1365-220-M	2018/11/28	Heter	Roger
	A5	Revision Dimensions "D" : 3.9±0.5→3.7±0.5	2018/12/24	Heter	Roger
	A6	Revision Dimensions "D" : 1R5~3R3: 3.7±0.5→3.4±0.5	2019/1/30	Heter	Roger

- Low profile
  - Low core loss and low DCR
  - High rated current
  - High performance (Isat) realized by metal dust core
  - RoHS compliant and Halogen Free
  - Low EMI and low noise
- 
- Voltage Regulator Module
  - DC/DC converters
  - Thin type on-board power supply module for exchanger
  - Graphics cards
  - Laptops and PCs
  - SSD modules

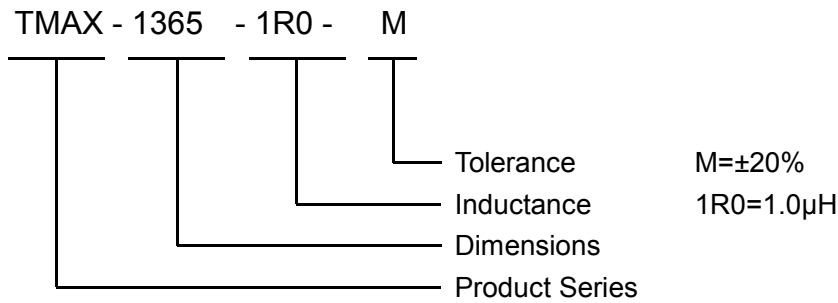

in millimeters

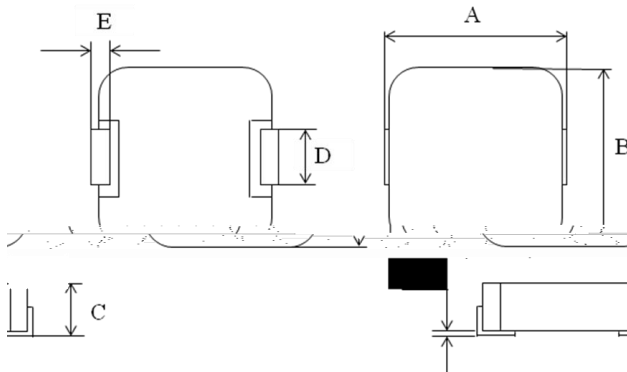

code	R47~1R0	1R5~3R3	4R7~101
A	13.8Max		
B	12.7±0.2		
C	6.5 Max.		
D	3.7±0.5	3.4±0.5	5.0±0.5
E	2.3±0.5		
F	0~0.20		

---

in millimeters

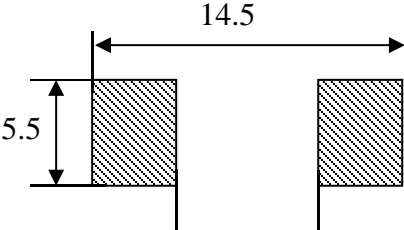

1. All test data is referenced to 23±3 °C and 45%RH to 70%RH ambient.
2. Test Instruments 3260B LCR Meter, 3265B Bias Current Source 100kHz,1V EUCOL-U2516B DC Low ohm meter.
3. Operating temperature range - 55 °C to + 125 °C ambient + self-temp. rise .
4. Isat: DC current (A) that will cause L<sub>0</sub> to drop approximately 30 %.
5. Idc: DC current (A) that will cause an approximate ΔT of 40 °C.
6. The part temperature (ambient + temp. rise) should not exceed 125 °C under worst case operating conditions. Circuit design, component placement, PWB trace size and thickness, airflow and other cooling provisions all affect the part temperature. Part temperature should be verified in the end application.
7. The rated current as listed is either the saturation current or the heat rating current depending on which value is lower.

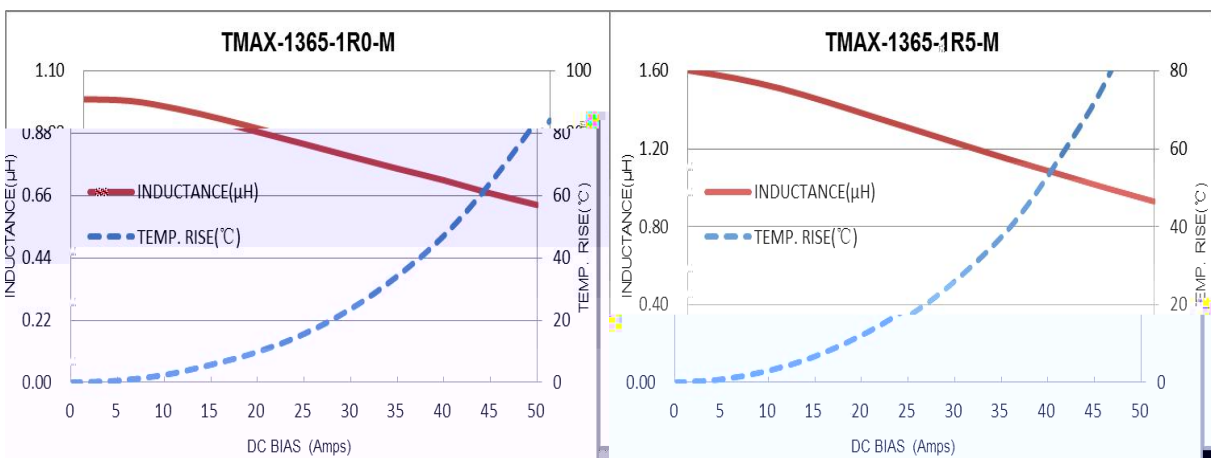
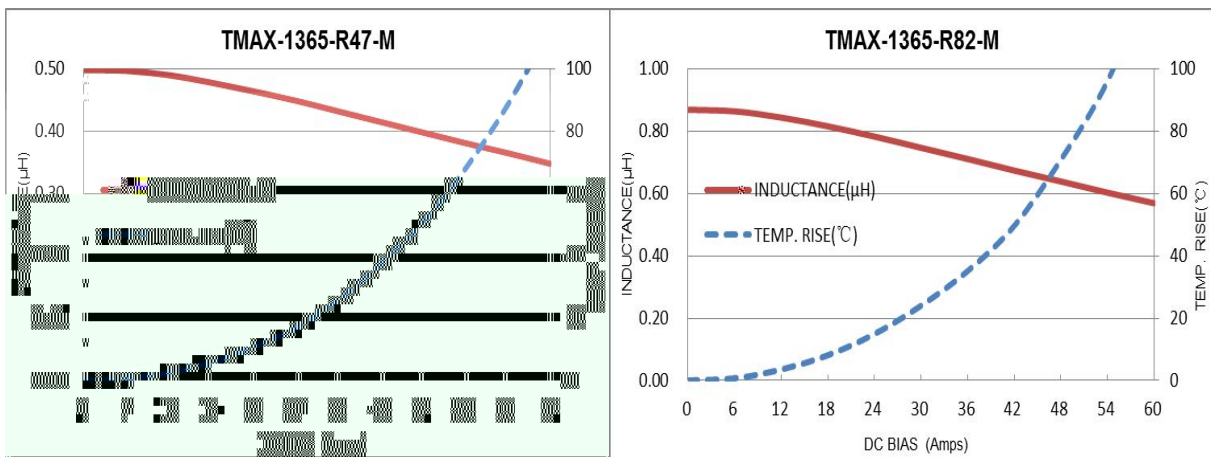

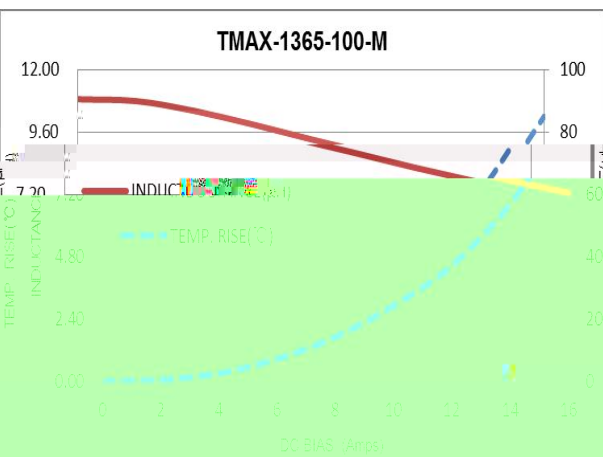
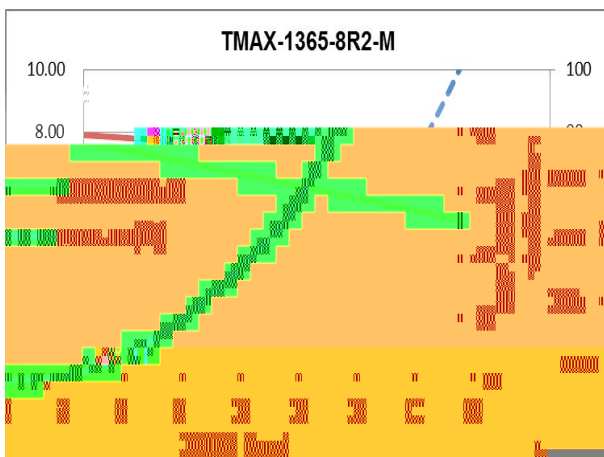
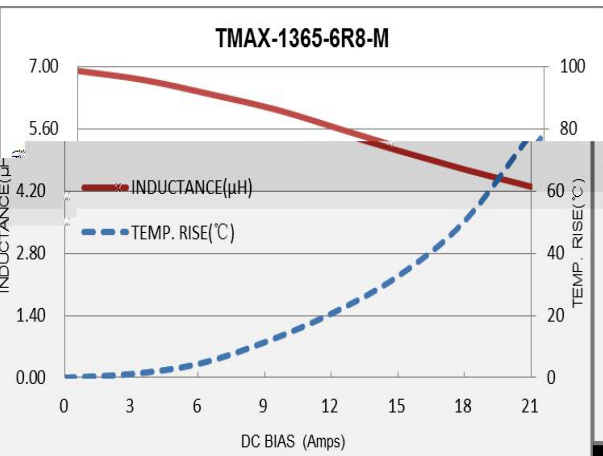
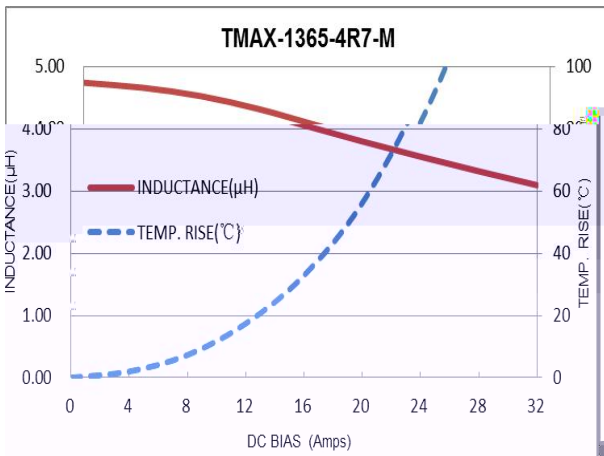
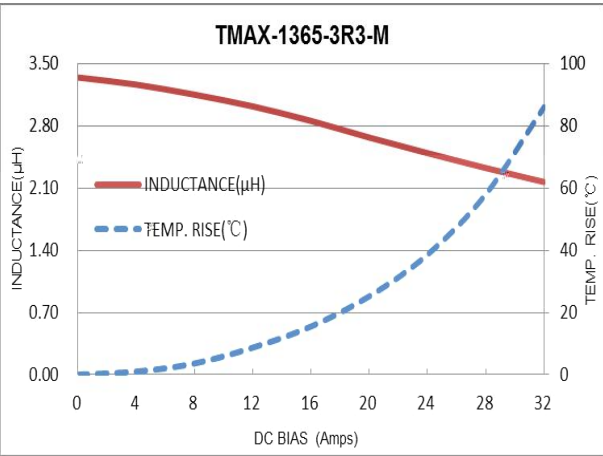
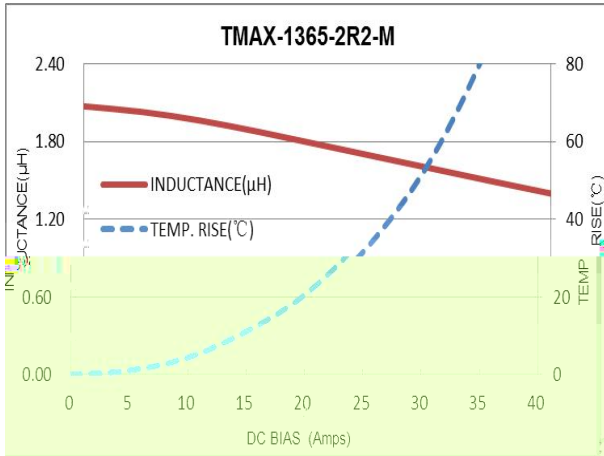

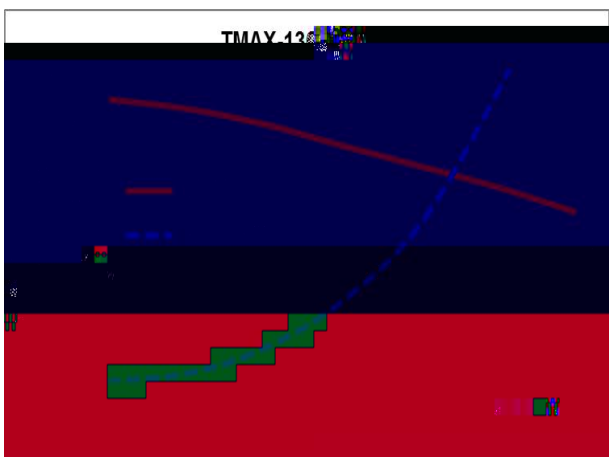
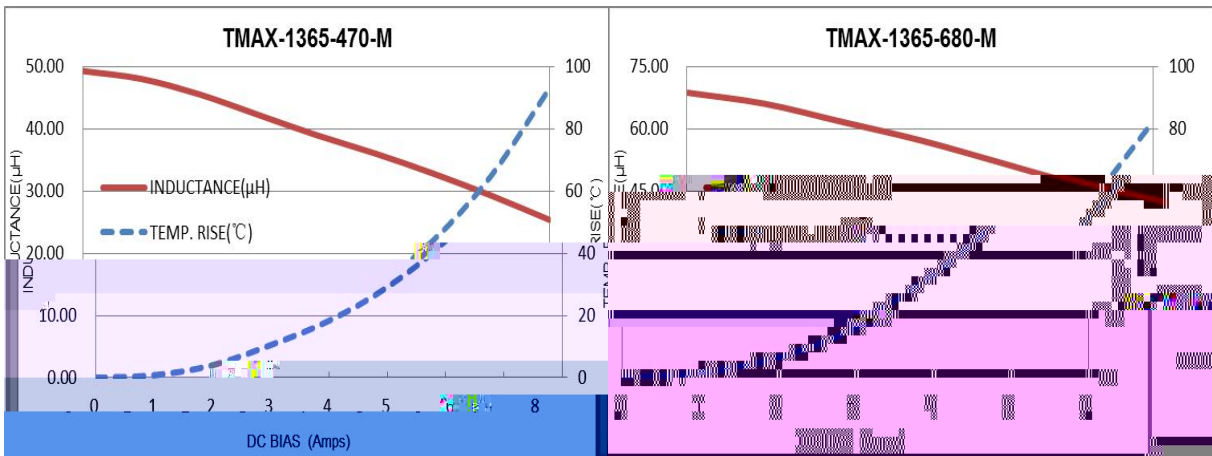
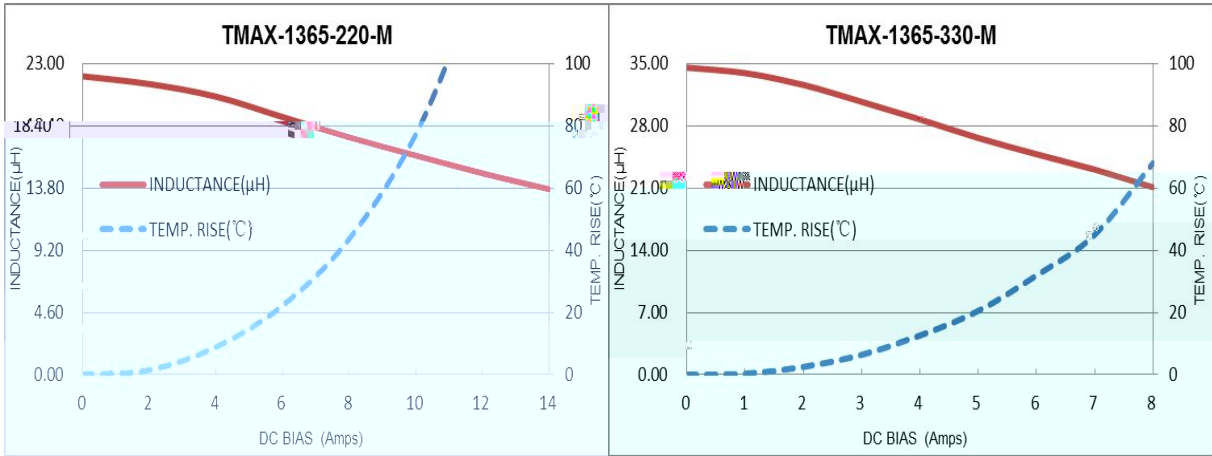

Revision: A6  
Control No.:

---

Thermal Shock	<p>1.Repeat 100 cycle as follow:  <math>(-55 \pm 2^{\circ}\text{C}, 30 \pm 3\text{minutes}) \rightarrow (\text{Room temperature, 5 minutes}) \rightarrow (+125 \pm 2^{\circ}\text{C}, 30 \pm 3\text{minutes}) \rightarrow</math>  <math>(\text{Room temperature, 5 minutes})</math></p> <p>2.Recovery: 48 + 4 / - 0 hours of recovery under the standard condition after the test</p>	
High Temperature Resistance	<p>1.Environment Temperature : <math>85 \pm 2^{\circ}\text{C}</math>                  2.Applied Current: Rated current                  3.Duration : 1,000 + 4 / - 0 hours</p>	$\Delta L/L_0 \leq \pm 5\%$
Humidity Resistance	<p>1.Environment Temperature: <math>60 \pm 2^{\circ}\text{C}</math>                  2.Relative Humidity: 90~95%                  3.Duration: 1,000 + 4 / - 0 hours</p>	No distinct damage in appearance.
Low Temperature Store	<p>1.Store temperature: <math>-55 \pm 2^{\circ}\text{C}</math> for total 1,000 + 4 / - 0 hours</p>	
High Temperature Store	<p>1.Store temperature: <math>+125 \pm 2^{\circ}\text{C}</math> for total 1,000 + 4 / - 0 hours</p>	



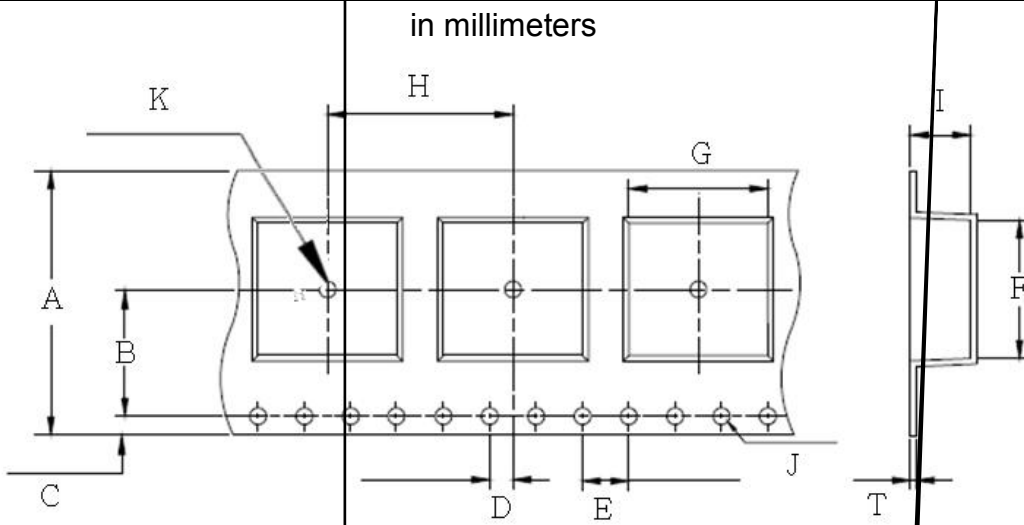

G	F	I	T	H	A
13.4 ± 0.1	13.4 ± 0.1	7.1 ± 0.1	0.5 ± 0.05	16.0 ± 0.1	24.0 ± 0.3
J	K	D	E	B	C
φ1.50 ± 0.1	φ1.50 ± 0.1	2.0 ± 0.1	4.0 ± 0.1	11.5 ± 0.1	1.75 ± 0.1

in millimeters

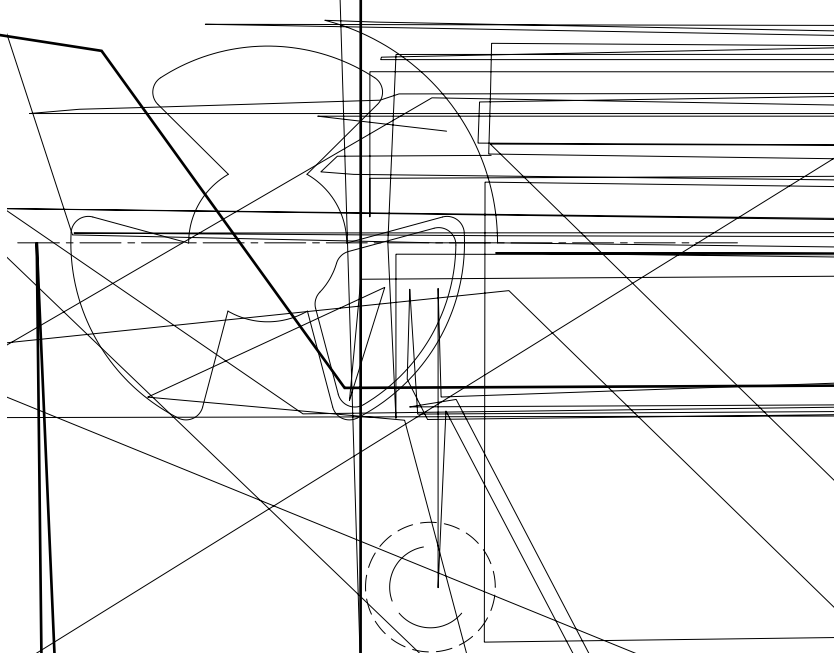

A	B	Color
24.5 ± 0.2	2.0 ± 0.2	Blue



# REFLOW



Rev. No.:  
 Class No.:

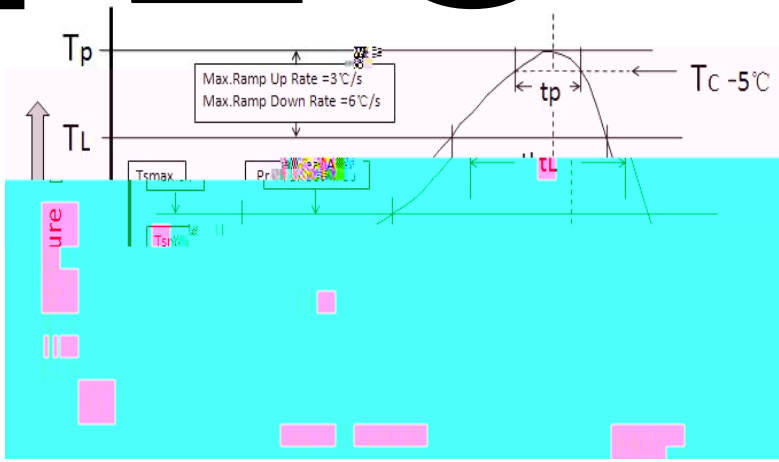

2.5mm	235	220
2.5mm	220	220

1.6mm	260	260	260
1.6-2.5mm	260	250	245
>2.5mm	250	245	245

	•Temperature min.(Tsm)	100	150
Preheat and Soak	•Temperature max.(Tsmax)	150	200
	•Time(ts):Tsm to Tsmax	60-120 Seconds	60-120 Seconds
Average ramp up rate TL to Tp		3 /Second Max.	3 /Second Max.
Liquidous temperature(TL)		183	183
Time at liquidous (tL)		60-150 Seconds	60-150 Seconds
Peak package body temperature(Tp)*		Table 1	Table 2
Time (tp)**within 5°C of the specified classification temperature(Tc)		20seconds** n	n 30seconds**
Average ramp-down rate			

- 500 pieces/reel
  
  - The following items shall be marked on the production and shipping
  - Label on the reel
- 
- |               |                           |
|---------------|---------------------------|
| ✓ Part No.    | ✓ Customer's Name         |
| ✓ Description | ✓ Customer's Part No.     |
| ✓ Quantity    | ✓ Manufacturer's Part No. |
| ✓ Produce No. | ✓ Manufacturer's Name     |
| ✓ Taping No.  | ✓                         |

➤ Provision to Abnormal Condition

This molded power inductor itself does not have any protective function in abnormal condition such as overload, short-circuit and open-circuit conditions, etc. Therefore, it shall be confirmed as the end product that there is no risk of smoking, fire, dielectric withstand voltage, insulation resistance, etc. in abnormal conditions to provide protective devices and/or protection circuit in the end product.

➤ Temperature Rise

Temperature rise of molded power inductor depends on the installation condition on end products. It shall be confirmed on the actual end product that temperature rise of molded power inductor is in the limit of specified temperature class.

➤ Dielectric Strength

Dielectric withstanding test with higher voltage than specific value will damage insulating material and shorten its life.

➤ Water

This molded power inductor must not be used in wet condition by water, coffee or any liquid because insulation strength becomes very low on the condition.

➤ Potting

If this molded power inductor is potted in some compound, coating material of magnet wire might be occasionally damaged. Please ask us if you intend to pot this molding.

➤ Detergent

Please consult our company once in case of this because the confirmation of reliability etc. is needed when the washing medicine is used for the molded power inductor.

➤ Notes

This electronic component has been designed and developed for usage in general electronic equipment only, not for usage in areas such as military, aerospace, aviation, transportation (automotive control, train control, ship control) etc.. TDG Holding Co., Ltd. must be informed about the in-